

ATS-evo

HEAVY DUTY SAFETY BOLT WITH SEISMIC CERTIFICATION

ICCONS[®]

Serious Connections[®]



First in Safety, First in Seismic C2 Certification

SAFE INSTALLATION

Optimal expansion
guaranteed by the coupling
of the cone and body



UNIFORM EXPANSION

Single piece
three expanding segments



ANTI-ROTATION

The special bush shape
prevents rotation



APPLICATIONS:

Steel/Aluminium constructions which require
a high certified level of safety

- Suspended applications
- Data centres & high risk applications
- Heavy duty machinery
- Airports & transport infrastructure
- Structural applications in seismic areas
- Bridging & tunnelling
- Public infrastructure

www.iccons.com.au

ATS-evo

Heavy duty safety bolt with seismic certification

ATS-evo S



Hex head bolt, Class 8.8
Zinc clear coating

ZINC

Part No.	Description	mm	Clearance mm	Seismic Certification			Socket mm	qty
				mm	mm	mm		
ATSeS10070 (79302b10070)	M6x70	10	12	10	70	10	50	
ATSeS10080 (79302b10080)	M6x80	10	12	20	80	10	50	
ATSeS10110 (79302b10110)	M6x110	10	12	50	110	10	50	
ATSeS12080 (79302b12080)	M8x80	12	14	10	80	13	25	
ATSeS12090 (79302b12090)	M8x90	12	14	20	90	13	25	
ATSeS12120 (79302b12120)	M8x120	12	14	50	120	13	25	
ATSeS15090 (79302b15090)	M10x90	15	17	10	90	17	20	
ATSeS15100 (79302b15100)	M10x100	15	17	20	100	17	20	
ATSeS15130 (79302b15130)	M10x130	15	17	50	130	17	20	
ATSeS15180 (79302b15180)	M10x180	15	17	100	180	17	20	
ATSeS18110 (79302b18110)	M12x110	18	20	10	110	19	20	
ATSeS18125 (79302b18125)	M12x125	18	20	25	125	19	20	
ATSeS18150 (79302b18150)	M12x150	18	20	50	150	19	20	
ATSeS18200 (79302b18200)	M12x200	18	20	100	200	19	20	
ATSeS24125 (79302b24125)	M16x125	24	26	10	125	24	10	
ATSeS24140 (79302b24140)	M16x140	24	26	25	140	24	10	
ATSeS24165 (79302b24165)	M16x165	24	26	50	165	24	10	
ATSeS24215 (79302b24215)	M16x215	24	26	100	215	24	10	
ATSeS28160* (79302b28160)	M20x160	28	31	10	160	30	4	
ATSeS28180* (79302b28180)	M20x180	28	31	30	180	30	4	
ATSeS28210* (79302b28210)	M20x210	28	31	60	210	30	4	
ATSeS28250* (79302b28250)	M20x250	28	31	100	250	30	4	
ATSeS32180* (79302b32180)	M24x180	32	35	10	180	36	4	
ATSeS32200* (79302b32200)	M24x200	32	35	30	200	36	4	
ATSeS32230* (79302b32230)	M24x230	32	35	60	230	36	4	

* Contact ICCONS for availability - leadtimes may apply

ATS-evo B

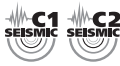

Threaded bar, Class 8.8
Zinc clear coating

ZINC

Part No.	Description	mm	Clearance mm	Seismic Certification			Socket mm	qty
				mm	mm	mm		
ATSeB10070 (79402b10070)	M6x70	10	12	10	70	10	50	
ATSeB10080 (79402b10080)	M6x80	10	12	20	80	10	50	
ATSeB10110 (79402b10110)	M6x110	10	12	50	110	10	50	
ATSeB12080 (79402b12080)	M8x80	12	14	10	80	13	25	
ATSeB12090 (79402b12090)	M8x90	12	14	20	90	13	25	
ATSeB12120 (79402b12120)	M8x120	12	14	50	120	13	25	
ATSeB15090 (79402b15090)	M10x90	15	17	10	90	17	20	
ATSeB15100 (79402b15100)	M10x100	15	17	20	100	17	20	
ATSeB15130 (79402b15130)	M10x130	15	17	50	130	17	20	
ATSeB15180 (79402b15180)	M10x180	15	17	100	180	17	20	
ATSeB18110 (79402b18110)	M12x110	18	20	10	110	19	20	
ATSeB18125 (79402b18125)	M12x125	18	20	25	125	19	20	
ATSeB18150 (79402b18150)	M12x150	18	20	50	150	19	20	
ATSeB18200 (79402b18200)	M12x200	18	20	100	200	19	20	
ATSeB24125 (79402b24125)	M16x125	24	26	10	125	24	10	
ATSeB24140 (79402b24140)	M16x140	24	26	25	140	24	10	
ATSeB24165 (79402b24165)	M16x165	24	26	50	165	24	10	
ATSeB24215 (79402b24215)	M16x215	24	26	100	215	24	10	
ATSeB28160* (79402b28160)	M20x160	28	31	10	160	30	4	
ATSeB28180* (79402b28180)	M20x180	28	31	30	180	30	4	
ATSeB28210* (79402b28210)	M20x210	28	31	60	210	30	4	
ATSeB28250* (79402b28250)	M20x250	28	31	100	250	30	4	
ATSeB32180* (79402b32180)	M24x180	32	35	10	180	36	4	
ATSeB32200* (79402b32200)	M24x200	32	35	30	200	36	4	
ATSeB32230* (79402b32230)	M24x230	32	35	60	230	36	4	

* Contact ICCONS for availability - leadtimes may apply

ATS-evo SK

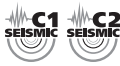
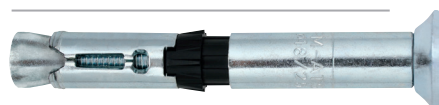

Hex socket countersunk head screw
Class 8.8 Zinc clear coating

ZINC

Part No.	Description	mm	Clearance mm	Seismic Certification			Socket mm	qty
				mm	mm	mm		
ATSeSK10070 (79303b10070)	M6x70	10	12	15	70	17	5	50
ATSeSK10080 (79303b10080)	M6x80	10	12	25	80	17	5	50
ATSeSK12080 (79303b12080)	M8x80	12	14	16	80	21	6	25
ATSeSK12090 (79303b12090)	M8x90	12	14	26	90	21	6	25
ATSeSK15090 (79303b15090)	M10x90	15	17	17	90	26	7	20
ATSeSK15100 (79303b15100)	M10x100	15	17	27	100	26	7	20
ATSeSK18125 (79303b18125)	M12x125	18	20	33	125	31	8	20

VERSIONS:

- hex head bolt
- threaded stud with hex nut
- hex socket countersunk head screw

PRODUCT FEATURES:

- Class 8.8 steel
- thick shear sleeve for high shear strength
- special nylon bush
- white zinc plated

SUITABLE BASE MATERIALS:

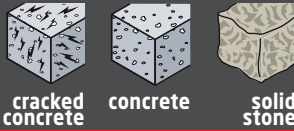

CERTIFICATIONS:

- Seismic certification C1 - C2
- OPTION 1: For cracked concrete
- F120 fire resistance certification

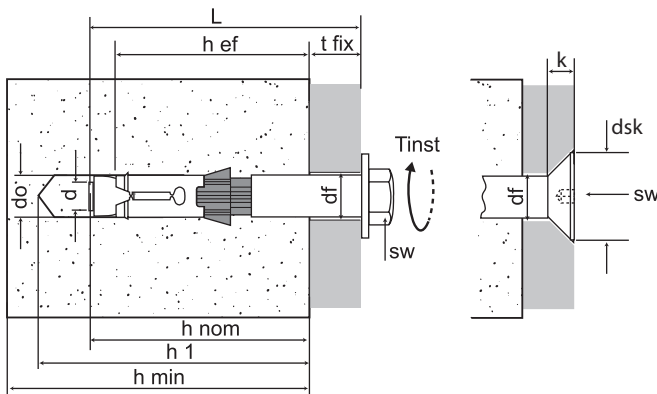
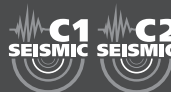

- d = anchor diameter
- do = hole diameter
- df = clearance hole in fixture
- dsk = countersunk head diameter
- tfix = fixture thickness
- sw = socket size
- k = countersunk head depth
- L = anchor length
- h₁ = hef
- h_{ef} = minimum hole depth
- h_{min} = minimum depth of anchor
- h_{nom} = nominal embedment depth
- T_{inst} = torque

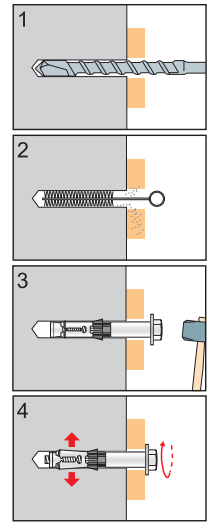

DESIGN⁽¹⁾ AND RECOMMENDED⁽²⁾ LOADS

Single anchor with large anchor spacing and edge distances in cracked and non-cracked concrete C20/25

Anchor		M6	M8	M10	M12	M16	M20*	M24*		
Minimum support thickness	h _{min}	mm	100	120	140	180	200	250	300	
Minimum hole depth	h ₁	mm	75	85	95	115	130	160	180	
Nominal embedment depth	h _{nom}	mm	60	70	80	100	115	145	165	
Minimum depth of anchorage	h _{ef}	mm	49	59	67	88	99	125	150	
Hole diameter	d ₀	mm	10	12	15	18	24	28	32	
Spacing	S _{cr,N}	mm	147	177	201	264	297	375	450	
Edge distance	C _{cr,N}	mm	74	89	101	132	149	188	225	
Tensile non-cracked concrete	N _{rd,ucr}	kN	10,7	15,2	18,4	27,7	33,1	38,0	50,0	
	N _{ucr}	kN	7,7	10,9	13,2	19,8	23,6	27,0	35,0	
Tensile cracked concrete	N _{rd,cr}	kN	6,0	8,0	10,7	16,7	23,7	28,0	35,0	
	N _{cr}	kN	4,3	5,7	7,6	11,9	16,9	20,0	25,0	
Shear ⁽³⁾	V _{rd}	kN	11,2	20,8	33,6	40,0	77,6	85,0	100	
	V	kN	8,0	14,9	24,0	28,6	55,4	60,0	70	
Seismic Resistance Category C1	Tensile	N _{rd,seis C1}	kN	4,5	8,0	10,7	16,7	23,7	-	-
		N _{seis C1}	kN	3,2	5,7	7,6	11,9	16,9	-	-
	Shear ⁽³⁾	V _{rd,seis C1}	kN	7,8	10,4	16,0	16,0	38,8	-	-
		V _{seis C1}	kN	5,6	7,4	11,4	11,4	27,7	-	-
Seismic Resistance Category C2	Tensile	N _{rd,seis C2}	kN	-	2,6	5,2	10,2	19,2	-	-
		N _{seis C2}	kN	-	1,9	3,7	7,3	13,7	-	-
	Shear ⁽³⁾	V _{rd,seis C2}	kN	-	8,2	13,6	13,6	35,1	-	-
		V _{seis C2}	kN	-	5,8	9,7	9,7	25,1	-	-
Minimum spacing	S _{min}	mm	50	60	70	80	100	125	150	
	for C	mm	75	90	100	150	200	250	300	
Minimum edge distance	C _{min}	mm	50	60	70	80	100	125	150	
	for S	mm	75	90	100	150	200	250	300	
Shear C = Cmin	V _{rd,cmin}	kN	3,3	4,5	5,8	7,5	11,0	14,3	23,7	
	V _{cmin}	kN	2,4	3,2	4,2	5,4	7,8	10,2	16,9	
Torque	T _{inst}	Nm	10	20	45	80	150	170	200	

⁽¹⁾ The design loads N_{rd} and V_{rd} derive from the characteristic loads on the ETA 10/0423 certification and are inclusive of the partial safety factors γ_m proportional to each diameter (see ETA).

⁽²⁾ The recommended loads N and V derive from the characteristic loads on the ETA 10/0423 certification and are inclusive of the partial safety factors γ_r=1.4 and γ_m proportional to each diameter (see ETA).

⁽³⁾ Shear values valid with distance from the edge C > 10 x h_{ef}

The load values are only valid if the installation has been carried out correctly. The design engineer is responsible for the designing and calculation of the fixing. The designing and calculation of the anchorage should be carried out in accordance with ETAG001-C or CEN/TS 1992/4 or under Seismic action acc.to TR045.

* Sizes in process of being CERTIFIED, the values derive from Friulsider tests in accordance with the European guideline ETAG001.

More products from ICCONS® seismic certified range

▶ FM-753® CRACK NAUTILUS			
▶ FM-753® CRACK - INOX A4- 316SS			
▶ BIS-PE PURE EPOXY			
▶ BIS-V VINYLESTER			



ICCONS® PTY LTD

VICTORIA - HEAD OFFICE

12-18 Produce Drive, Dandenong South, Vic, 3175
 P: 03 9706 4344
 F: 03 9768 3329
 E: sales@iccons.com.au

NSW Branch

Unit 50, 317-321 Woodpark Road, Smithfield
 New South Wales, 2164
 P: 02 9757 3439
 F: 02 9756 6587
 E: salesnsw@iccons.com.au

QLD Branch

4/ 3375 Pacific Hwy, Slacks Creek, Queensland, 4127
 P: 07 3290 5144
 F: 07 3290 5166
 E: salesqld@iccons.com.au

S.A Branch

15 Light Terrace, Thebarton, South Australia, 5031
 P: 08 8234 5535
 F: 08 8354 4689
 E: salessa@iccons.com.au

W.A. Branch

90 Christable Way, Landsdale
 Western Australia, 6065
 P: 08 6305 0008
 F: 08 6305 0011
 E: saleswa@iccons.com.au

New Zealand

13D Paul Mathews Road, Albany, Auckland, 0632
 P: TBA
 F: TBA
 E: TBA